

Delta 40

PENDANT

INSTALLATION INSTRUCTIONS

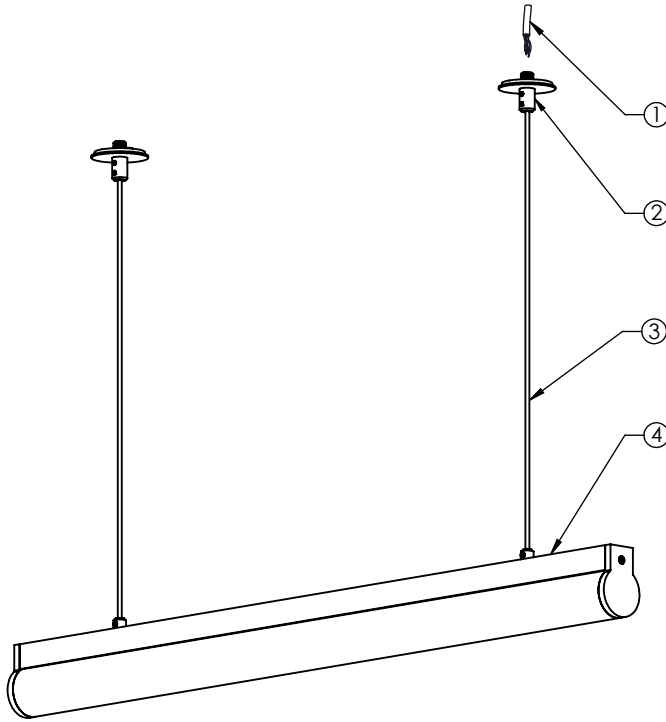
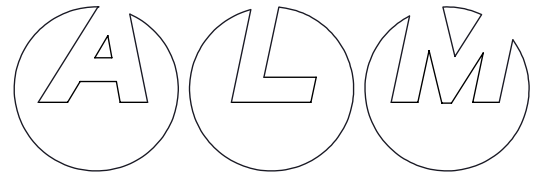

1	Power feed (by others)
2	Canopy assembly
3	Flexible power cord
4	Fixture assembly

Hard Ceiling Canopy - Plasterboard

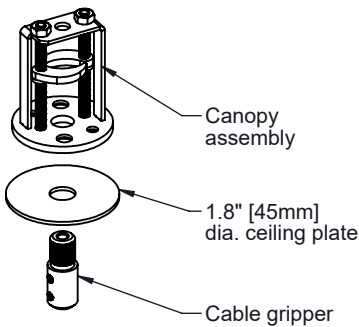

Hard Ceiling Canopy - Concrete/Wood/Metal

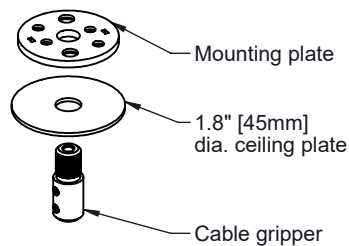

INSTRUCTIONS:

1. Mark the position of the fixture suspension points as specified on the cut sheet.
2. Mount canopy kits to ceiling, see instructions for details on various canopy options.
3. Energize.

GENERAL NOTE:

- * Turn power off before beginning.
- * Do not connect to an ungrounded supply.
- * Consult a qualified electrician to ensure correct branch circuit conductor.
- * This product must be installed in accordance with the applicable installation code by a person familiar with the construction and operation of the product and the hazards involved.
- * Save these instructions.

- A. Cut out a 1-3/8" [35mm] dia. hole at previously marked suspension point.
- B. Bring the power cord from the fixture assembly through the cable gripper, ceiling plate and canopy assembly.
- C. Splice the wires as required.
Wires for connection are clearly labeled.
- D. Secure the canopy assembly to the ceiling by tightening the captive screws. This will lower and lock the claws onto the ceiling.
- E. Slide the ceiling plate and cable gripper up and screw into the canopy assembly.
- F. Level the fixture and secure the power cord with the set screws on the cable gripper.

Note: If used as suspension only, follow the same steps as above except for electrical connection.

- A. Drill a 1/2" [13mm] dia. hole at previously marked suspension point.
- B. Bring the power cord from the fixture assembly through the cable gripper, ceiling plate and mounting plate.
- C. Splice the wires as required.
Wires for connection are clearly labeled.
- D. Mount the mounting plate to the ceiling using hardware provided.
- E. Slide the ceiling plate and cable gripper up and screw into the canopy assembly.
- F. Level the fixture and secure the power cord with the set screws on the cable gripper.

Note: If used as suspension only follow the same steps as above except for electrical connection.